

1port Remote I/O Controller
(dry / wet contact support)

CIE-H12 User Manual

Version 2.4



Sollae Systems Co., Ltd.

<https://www.ezTCP.com>



This symbol, found on your product or on its packaging, indicates that this product should not be treated as household waste when you wish to dispose of it. Instead, it should be handed over to an applicable collection point for the recycling of electrical and electronic equipment. By ensuring this product is disposed of correctly, you will help prevent potential negative consequences to the environment and human health, which could otherwise be caused by inappropriate disposal of this product. The recycling of materials will help to conserve natural resources. For more detailed information about the recycling of this product, please contact your local city office, household waste disposal service or the retail store where you purchased this product.

Contents

- Contents** - 2 -
- 1 Introduction**..... - 5 -
 - 1.1 Introduction - 5 -
 - 1.2 Features - 5 -
 - 1.3 Application Examples - 6 -
 - 1.4 Components - 7 -
 - 1.5 Specification - 7 -
 - 1.5.1 H/W specification - 7 -
 - 1.5.2 S/W specification - 7 -
 - 1.6 Interface - 8 -
 - 1.6.1 Input Ports - 8 -
 - 1.6.2 Output Ports - 10 -
 - 1.6.3 Ethernet Interface - 11 -
 - 1.6.4 Power - 11 -
 - 1.6.5 System LED - 12 -
 - 1.6.6 ISP Switch - 12 -
- 2 Installation and Test**..... - 13 -
 - 2.1 Installation - 13 -
 - 2.1.1 Setting Network Aera - 13 -
 - 2.2 Test operation - 15 -
 - 2.2.1 Modbus/TCP Test - 15 -
 - 2.2.2 HTTP Test with a WEB browser - 17 -
- 3 Configuration** - 18 -
 - 3.1 Configuration with ezManager - 18 -
 - 3.1.1 Configuration via LAN - 18 -
- 4 Operation Modes** - 19 -
 - 4.1 What is the Operation Mode? - 19 -
 - 4.2 How to change the mode to another - 19 -
 - 4.3 Comparison of the each mode - 20 -
 - 4.4 Normal Mode - 20 -
 - 4.5 ISP mode - 20 -
 - 4.5.1 Upgrading Firmware - 20 -
 - 4.5.2 Upgrading HTML - 20 -

4.5.3 *Revoking Security Options*..... - 20 -

5 Methods for I/O control - 21 -

5.1 MODBUS/TCP - 21 -

 5.1.1 *Related Parameters*..... - 21 -

 5.1.2 *Modbus/TCP Slave Mode*..... - 22 -

 5.1.3 *Modbus/TCP Master Mode*..... - 22 -

 5.1.4 *TCP Connection Modes*..... - 23 -

 5.1.5 *Initial Output Value*..... - 23 -

 5.1.6 *Write Pulse*..... - 23 -

 5.1.7 *Communication with HMI*..... - 24 -

5.2 Macro Mode..... - 25 -

 5.2.1 *Operator*..... - 25 -

 5.2.2 *Operand*..... - 25 -

 5.2.3 *An Example of Equations*..... - 26 -

5.3 Monitoring and controlling on Web (HTTP)..... - 27 -

 5.3.1 *Changing port number for HTTP*..... - 27 -

 5.3.2 *Uploading Users' Webpage*..... - 28 -

6 System Management..... - 29 -

6.1 Upgrading Firmware..... - 29 -

 6.1.1 *Firmware*..... - 29 -

 6.1.2 *Processes*..... - 29 -

6.2 Changing Homepage..... - 31 -

 6.2.1 *Webpage*..... - 31 -

 6.2.2 *Processes*..... - 31 -

6.3 Status Monitoring..... - 34 -

 6.3.1 *Using TELNET*..... - 34 -

 6.3.2 *Checking status by ezManager*..... - 36 -

7 Additional Functions..... - 38 -

7.1 Security..... - 38 -

 7.1.1 *Restriction of Access (ezTCP Firewall)*..... - 38 -

 7.1.2 *Setting Password*..... - 38 -

7.2 Option Tab Functions..... - 39 -

 7.2.1 *Notify IP Change*..... - 39 -

 7.2.2 *Debugging Message*..... - 40 -

7.3 I/O Tab Functions..... - 42 -

 7.3.1 *Notify Input or Output Port Change*..... - 42 -

- 7.3.2 *Valid Time*..... - 44 -
- 7.3.3 *Delay*..... - 44 -
- 7.4 Internet Switch - 44 -
- 8 Self-Test in Trouble - 45 -**
- 8.1 Searching problem with ezManager..... - 45 -
- 8.2 Connection Problem over Modbus/TCP - 46 -
- 8.3 Communication Problem over Modbus/TCP - 47 -
- 9 Related material..... - 48 -**
- 9.1 Technical Documents - 48 -
- 9.2 Smart phone application..... - 48 -
- 10 Technical Support and Warranty..... - 49 -**
- 10.1 Technical Support - 49 -
- 10.2 Warranty..... - 49 -
- 10.2.1 *Refund*..... - 49 -
- 10.2.2 *Free Repair Services* - 49 -
- 10.2.3 *Charged Repair Services*..... - 49 -
- 11 Precaution and Exemption from Liability - 50 -**
- 11.1 Precaution..... - 50 -
- 11.2 Exemption from Liability..... - 51 -
- 11.2.1 *English version*..... - 51 -
- 11.2.2 *French version*..... - 51 -
- 12 History - 54 -**

1 Introduction

1.1 Introduction

In the era of Ubiquitous Environment, many kinds of systems which use sensors like temperature, humidity or pressure and controlling the power of remote devices have been developing. CIE-H12 monitors those sensors and controls the remote devices. It detects digital inputs from the sensors' outputs and controls the relay outputs. HTTP, Modbus/TCP and Macro mode can be used for these functions.

CIE-H12 has two input ports and one output port. One of the input ports is a dry-contact type and the other one is wet-contact. Thus, you are allowed to use it under both types of systems.

1.2 Features

- Remote I/O controller
- 2 Digital Input ports (Dry contact 1 port, Wet contact 1 port)
- 1 Digital Output Port (Relay interface)
- Supports Modbus/TCP and HTTP
- Stored Web server for simple management (custom web page)
- MACRO (stand-alone operation supports simple logical expressions)
- Easy configuration program (ezManager)

1.3 Application Examples

- remote I/O device server

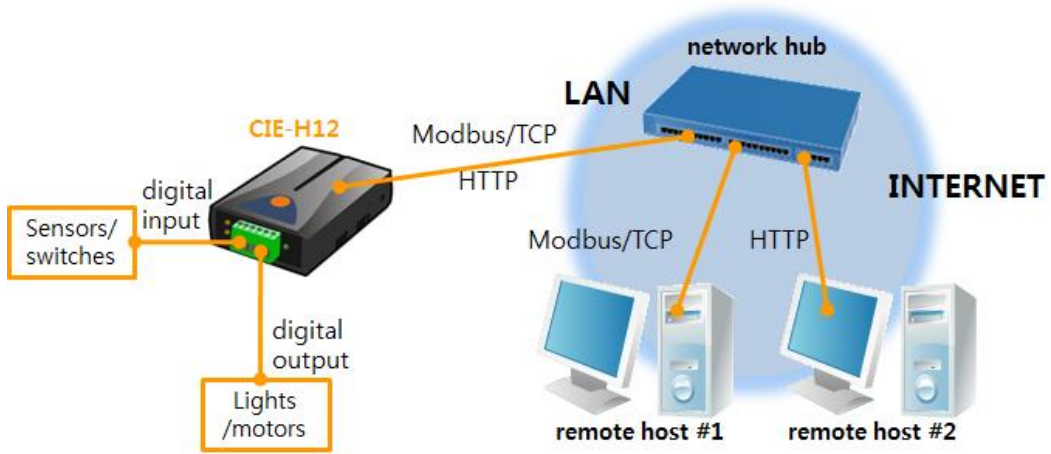

Figure 1-1 remote I/O device server

- Internet Switch

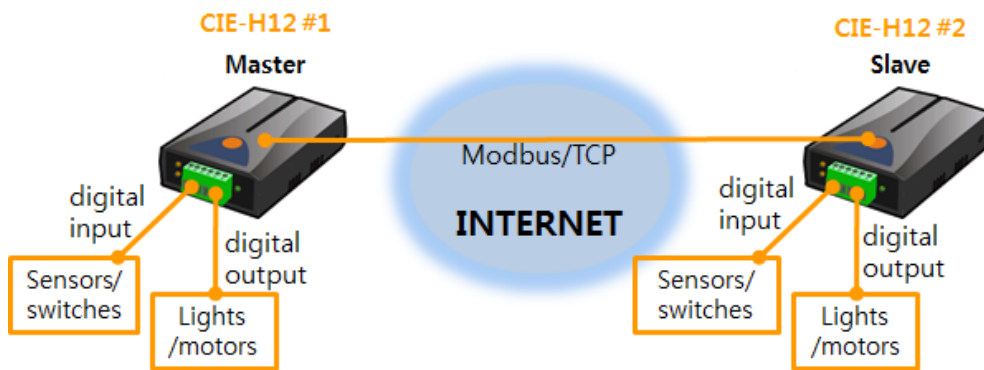

Figure 1-2 internet switch

- Macro mode

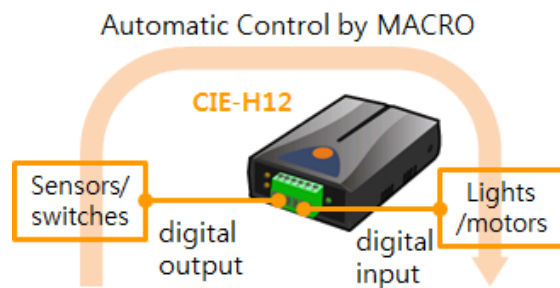

Figure 1-3 macro mode

1.4 Components

- CIE-H12
- 5V Power Adapter (optional)

1.5 Specification

1.5.1 H/W specification

Power	Input Power	DC 5V (±10%)
	Current Consumption	305mA typical
Size	96mm x 57mm x 24mm	
Weight	Approximately 68g	
Interfaces	Digital Input	2 ports with photo couplers (2 input types)
	Digital Output	1 port with relays
	Network	RJ45
Network	Ethernet 10Base-T or 100Base-TX (Auto-Sensing) Auto MDI/MDIX(Cable Auto-sensing)	
Temperature	Operate: 0 ~ 70°C / Storage: -40 ~ 85°C	
Certification	CE, KC	
Environment	Follows Europe RoHS Directive	

Table 1-1 H/W specification

1.5.2 S/W specification

Protocol	TCP, UDP, IP, ICMP, ARP, DHCP, DNS lookup, DDNS, Modbus/TCP, HTTP, SMTP	
Diagnose	Online Debugging Function	
Operation mode	Normal	Normal communication mode
	ISP	F/W upgrade
Communication Mode	I/O server	Modbus/TCP – Slave/Master, Passive/Active Web Browser(HTTP), Macro(Stand-alone)
Programs	ezManager	Configuration program via LAN
	ModMap	Modbus/TCP Application for Windows

Table 1-2 S/W specification

1.6 Interface

1.6.1 Input Ports

CIE-H12 has two input ports and the each has different type with the other. The one is a "DRY CONTACT" type and the other one is a "WET CONTACT."

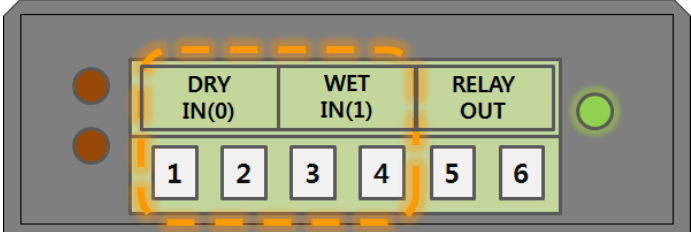

Figure 1-4 input ports (the front view)

In the front panel, the DRY IN(0) port is the dry contact type and the WET IN(1) port is the wet contact type.

- The switch input type (Dry contact)
The first input port is a dry contact type so you can give the input signal by a switch. Basically, this port is the same with the port WET IN(1) but has additional part for dry contact. Just use a switch for giving signal to this port.

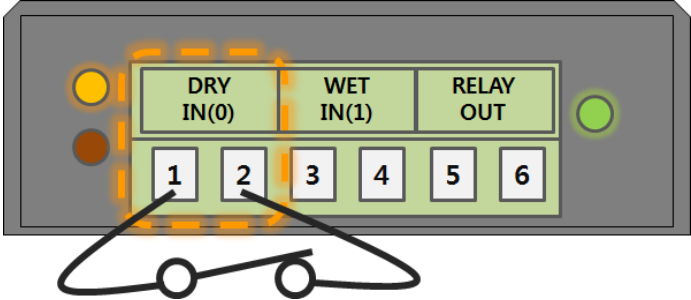

Figure 1-5 the dry contact input port

- The voltage input type (Wet contact)

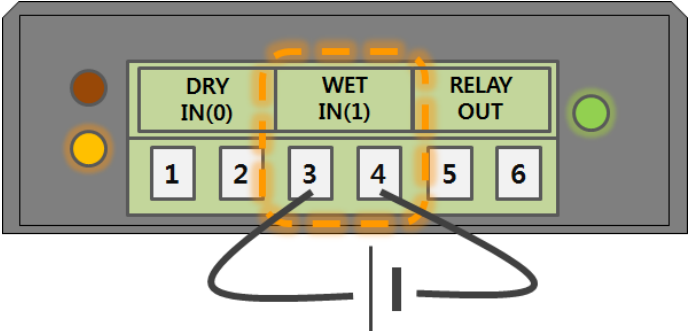

Figure 1-6 the wet contact input port

You can give a DC voltage to input signal to this port. This port is isolated by photo-couplers and you don't have to care about the polarity. The circuit diagram of the input port is shown in the figure below.

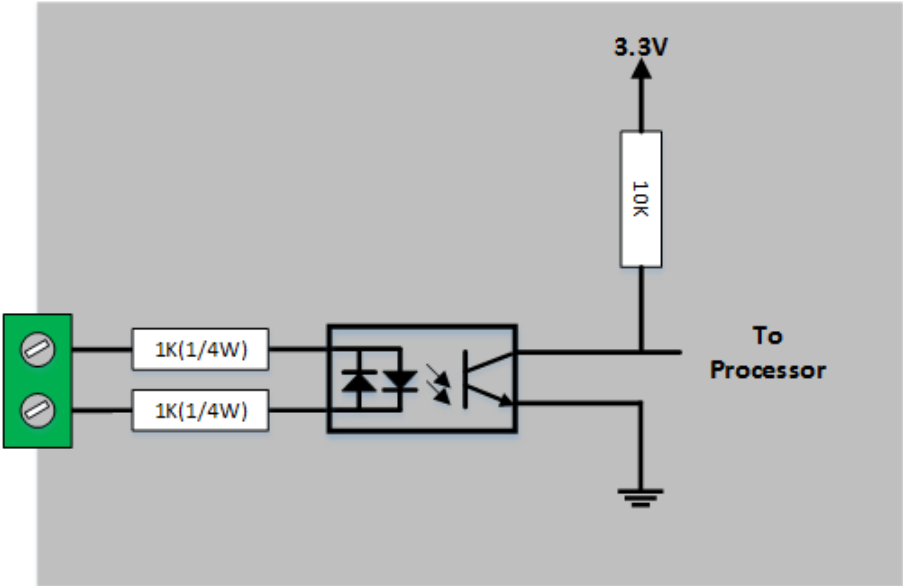

Figure 1-7 a circuit diagram of the input port

The voltage specification of the input port is as follows:

Over 5V	H	1
Under 1.2V	L	0
Max. Input Voltage	DC 24V	
Polarity	Auto Polarity	

Table 1-3 the voltage specification of the input ports

Use a (-) shaped screwdriver to connect it with users' devices since the output ports are interfaced with a 3.5mm terminal block,

1.6.2 Output Ports

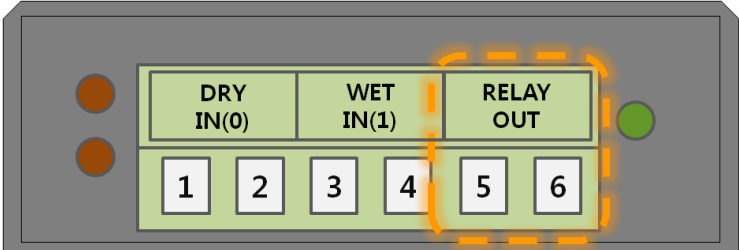

Figure 1-8 the output port (the front view)

The port 5 and 6 (OUTPUT) is output port and this port is interfaced with a relay (Normal Open) as shown below.

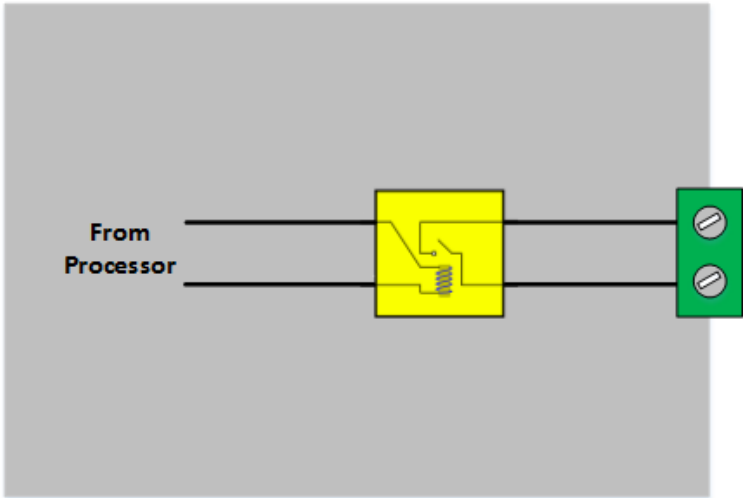

Figure 1-9 a circuit diagram of the output port

The output port operates as in the following

Value	Relay contact
0	OFF (open)
1	ON (short)

Table 1-4 values of the output port

The allowed output ports' electrical current of voltage conditions are as in the following:

Voltage Condition	Allowed current
DC28V	5A

Table 1-5 voltage conditions of the output port

- ☞ *Use a (-) shaped screwdriver to connect it with users' devices since the output ports are interfaced with a 3.5mm terminal block,*
- ☞ *CIE-H12 is most appropriate for switching devices in lower voltage conditions than that. Or High capacity relay is recommended.*

1.6.3 Ethernet Interface

An RJ45 connector is for the network interface of CIE-H12. You can use a UTP cable. It automatically senses 10Mbps or 100Mbps Ethernet. It also provides auto MDI/MDIX function that can automatically sense a 1:1 cable or cross over cable.

Each Ethernet device has its own hardware address (MAC address). CIE-H12 is shipped to the market with the hardware address set in the factory.

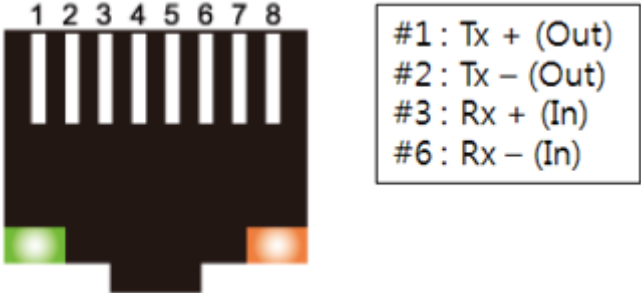

Figure 1-10 the RJ45 connector

1.6.4 Power

DC 5V is used for the power. The specification of the power jack is as following:

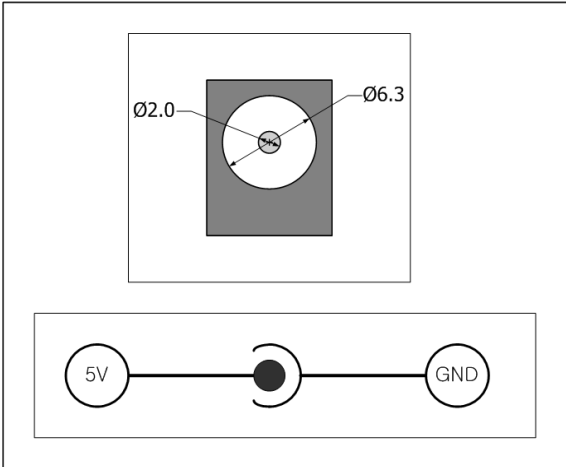

Figure 1-11 the power specification

1.6.5 System LED

CIE-H12 has 2 LEDs on RJ45 and the current system status LEDs for out port and input ports.

Each LED represents the following status:

place	name	color	LED status	description
RJ45	STS	Yellow	blinks in every second	assigned an IP address
			blinks 4 times at once	without being assigned an IP address by DHCP
			On	establishing a TCP connection
			Off	operating for the ISP mode
	LINK	Green	On	establishing a connection on a network
			blinks	transferring or receiving network data
Front panel	DI	Yellow	On	when input ports' signal is ON
	DO	Green	On	when the output port's signal is ON

Table 1-6 status of the system LED

1.6.6 ISP Switch

There is an ISP switch located on the side of the product. This button is for changing the mode to the ISP mode. If you press it over a second or supply power while pressing it, CIE-H12 will be operated as the ISP mode. In this mode, you can download the firmware file or HTML files.



Figure 1-12 ISP switch

In the ISP mode, you are allowed to reset a password or cancel access restriction. Use these modes when you are faced with the problems.

2 Installation and Test

2.1 Installation

In this section, we explain the way of CIE-H12 operation through a test. Basically, its input and output ports are independently used. Thus, you can use either the input ports only for monitoring or the output ports only for control. However, you can also correlatively use those ports by using the MACRO mode on the output ports.

Before testing CIE-H12, you should connect the Ethernet port to a PC. It will be no problem if the Ethernet connection is established through network hubs.



Figure 2-1 the connection between CIE-H12 and a PC

2.1.1 Setting Network Aera

This step is for setting both CIE-H12 and your PC to be located on the same network to establish a TCP connection.

- Setting of the PC

Add or change the IP address of the network adapter on your PC.

Click [Windows Control Panel] >> [Network Connections] and right click of your mouse to get into [Properties of the Network Adapter], then you will see the properties of [Internet Protocol (TCP/IP)]. Press the [Advanced Menu] button and add an IP Address as shown below.

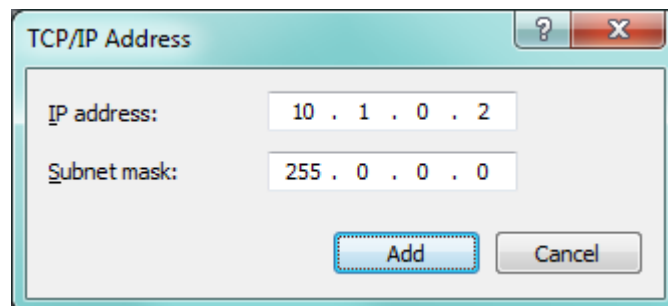

Figure 2-2 adding / changing an IP address

- Setting of CIE-H12

ezManager is the management tool for configuration of CIE-H12. This application is only for MS Windows and this is comfortable to use because it does not need installation process.

First, search your CIE-H12 via network. All the values of parameters are set to the default values in the factory. To apply it to your system, proper values should be set via ezManager.

Default values of some major parameters are listed on the table below. To do the following simple test, keep these values during the test.

Parameters		Values
Network	Local IP Address	10.1.0.1
	Subnet Mask	255.0.0.0
Option	Telnet	Checked
	IP Address Search	Checked
I/O Port	Web (HTTP)	Checked
	Web (HTTP) Port	80
	Modbus/TCP	Checked
	Master/Slave	Slave
	Connection Mode	Passive Connection
	Multiple Connection	1
	Local Port	502

Table 2-1 default values of some major parameters

☞ ***You can download the latest version of ezManager on the [Download] >> [Utility] page on our website.***

2.2 Test operation

2.2.1 Modbus/TCP Test

This is for checking the operation of Input and output ports of CIE-H12 via Modbus/TCP. In this instruction, offered Modbus/TCP test program was used.

Run ezManager. Then, you can see the window as shown below.

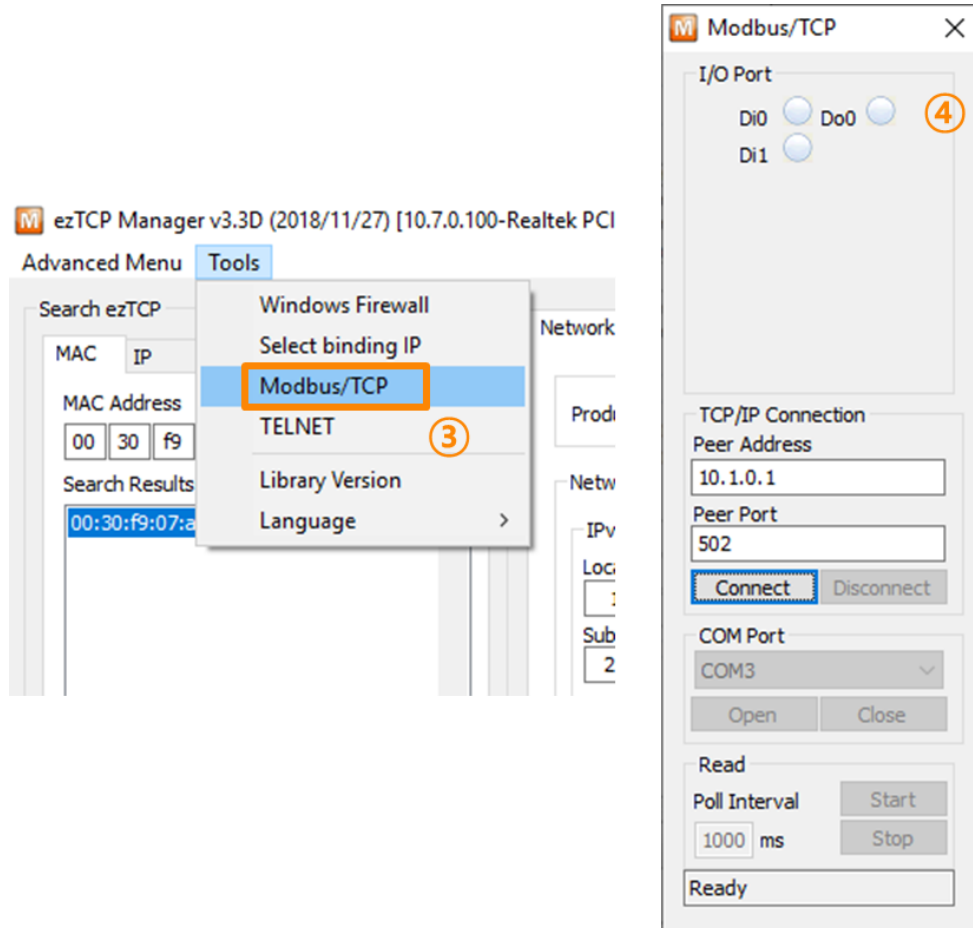

Figure 2-3 Modbus/TCP test program of the ezManager

- ① Search the connected CIE-H12 with [Search All] button.
- ② Select a MAC address of searched product on the [search result].
- ③ Press the [Tools] - [Modbus/TCP] button.
- ④ The test program will appear on the right side of the ezManager

☞ ***In the case of using previous versions of ezManager than 3.1F the test program is shown automatically when you success in searching the product.***

- Modbus/TCP test

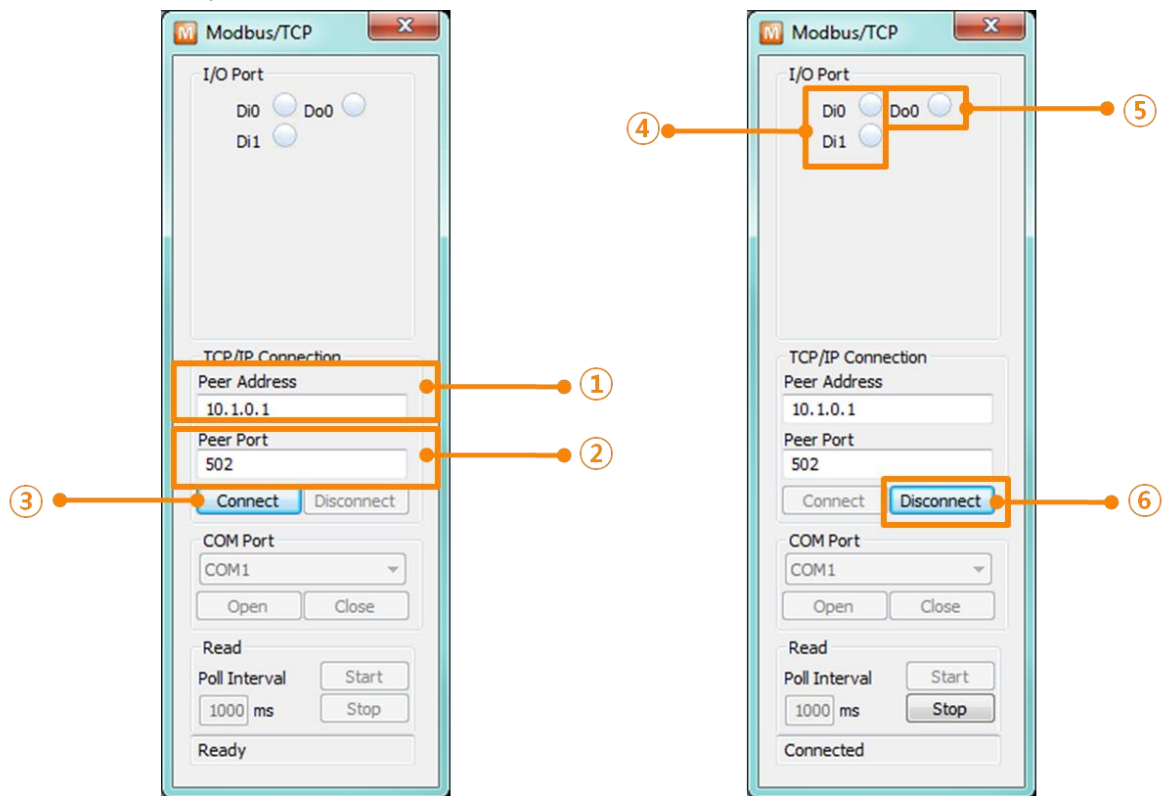

Figure 2-4 Modbus/TCP test

- ① Input the IP address of CIE-H12
- ② Input the local port for Modbus/TCP of CIE-H12

☞ ***In a local area network, ① and ② steps can be omitted.***

- ③ Try to connect by pressing [Connect] button
- ④ Then, check if the input LEDs are turned on or off with signal input
- ⑤ Check if the output LED is turned on or off with clicking the LEDs
- ⑥ Click the [Disconnect] button after the test is completed

2.2.2 HTTP Test with a WEB browser

This is for testing the operation of Input and output ports of CIE-H12 via HTTP. The test was implemented on a WEB browser. You can use WEB browsers such as MS Internet Explorer, Google Chrome and Mozilla Firefox.

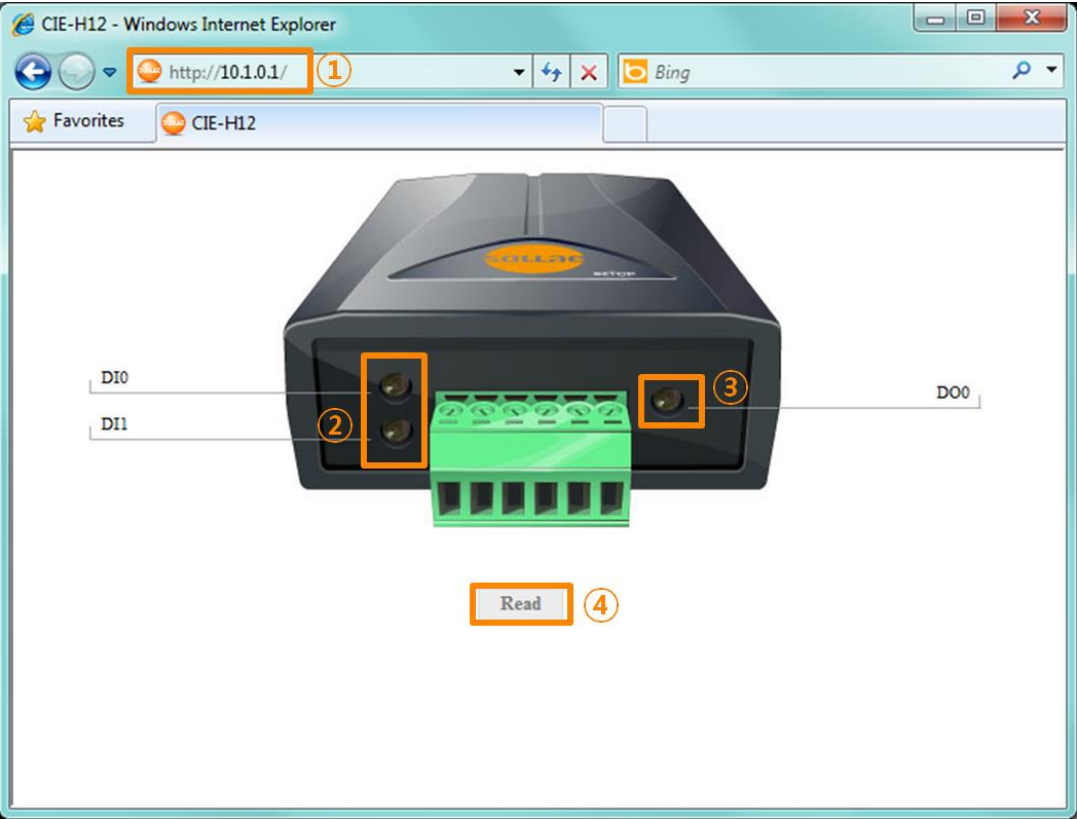

Figure 2-5 HTTP test

- ① Input the IP address of your CIE-H12 on the address field (Ex: 10.1.0.1).
- ② Check if the input LEDs are turned on or off with HIGH signal.
- ③ Check if the output LED is turned on or off with clicking the each of LEDs.
- ④ Press the [Read] button to update the status.

- The way to control output ports manually

	On/Off		Pulse
Parameter	o0 (Lower case)		p0 (Lower case)
Value	ON	OFF	Time (ms)
	1	0	1~10000
Example	http://10.1.0.1/index.html?o0=1		http://10.1.0.1/index.html?p0=1000

Table 2-2 The way to control output ports manually

3 Configuration

3.1 Configuration with ezManager

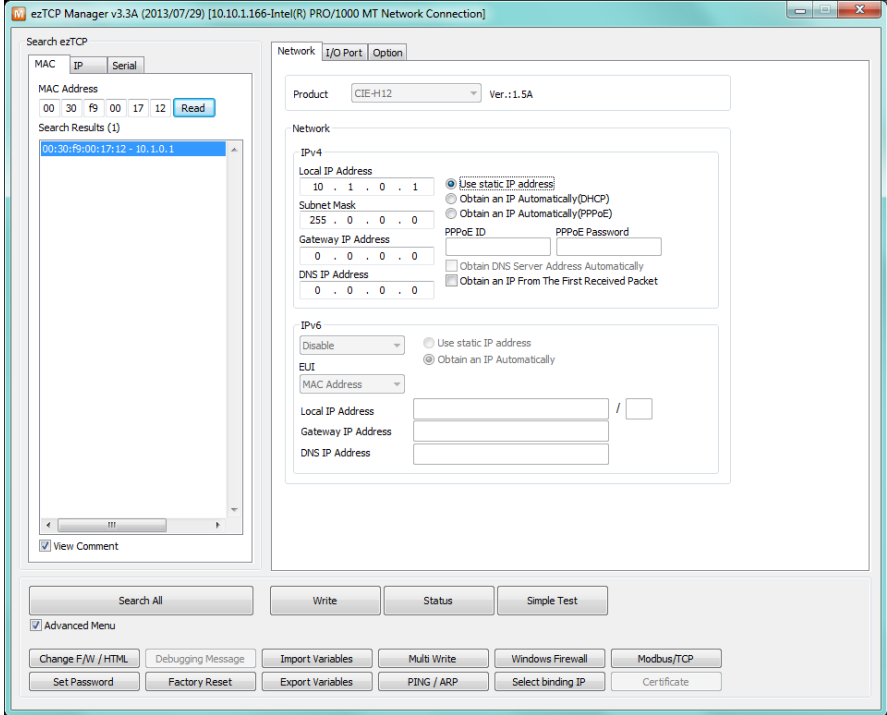

Figure 3-1 initial appearance of ezManager

3.1.1 Configuration via LAN

- Checklists

Make sure of the connection between your PC and CIE-H12 via Ethernet. If they are in the same network, [MAC Address search] button can be used. Otherwise, only [IP Address search] is allowed to use.

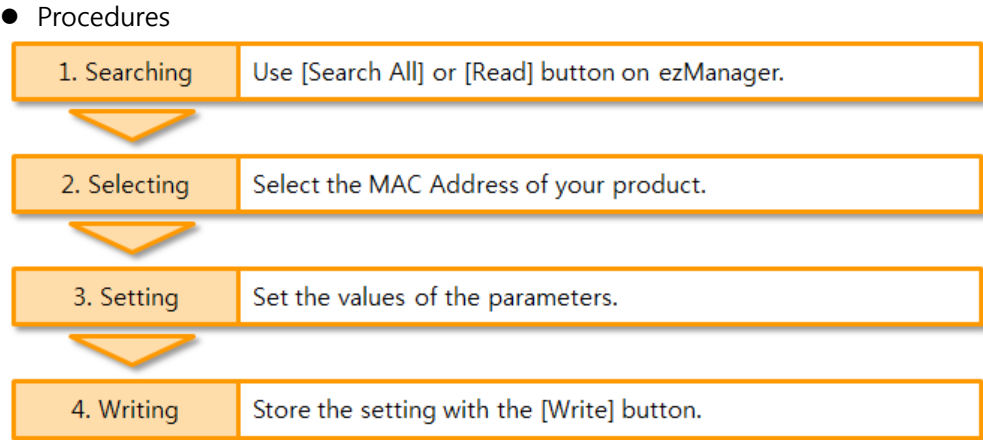

Figure 3-2 procedures for configuration via LAN

4 Operation Modes

4.1 What is the Operation Mode?

Each of two operation modes are designed for specific purposes, and those are as follows:

- Normal mode
This mode is for normal data communication and has 2 communication modes. Configuring parameters is also available in this mode.
- ISP mode
This mode is for upgrading firmware and HTML files. In addition, you can set environmental parameters even though the security options are activated. You can also reset the security options.

4.2 How to change the mode to another

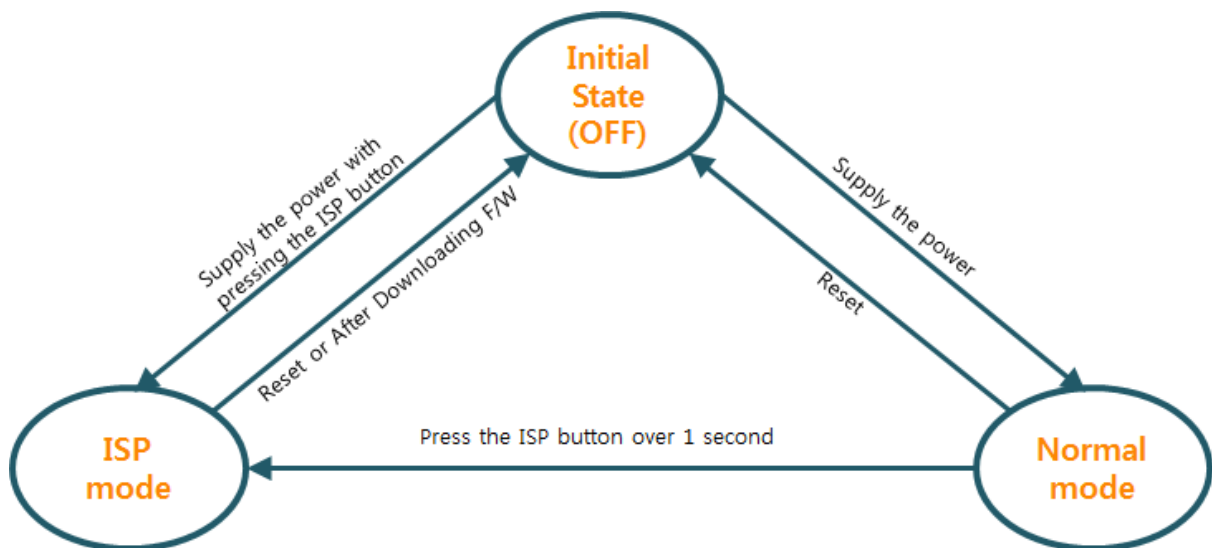

Figure 4-1 how to initiate each operation mode

4.3 Comparison of the each mode

The following table shows summaries of each mode.

Name	Entering
Normal	Supply the power.
ISP	Supply the power with pressing the ISP button or press the ISP button over 1 sec in other modes.

Table 4-1 comparison of the each mode

4.4 Normal Mode

In normal mode, there are 3 types of ways to monitor and control I/O.

Types	Description
Modbus/TCP	Control and monitor the I/O of CIE-H12 via Modbus/TCP. It supports both master and slave mode.
Macro	Users can automatically control the output ports by setting MACRO using some basic formula of Boolean Algebra. Users can not control the output ports through HTTP or Modbus/TCP.
WEB(HTTP)	Users can monitor and control CIE-H12 via HTTP

Table 4-2 digital I/O control types

4.5 ISP mode

4.5.1 Upgrading Firmware

ISP mode is for upgrading firmware. Upgrading Firmware is implemented by ezManager. For more details about this, please refer to the clause 6.1.

4.5.2 Upgrading HTML

ISP mode can also upgrade HTML files. For more details about this, please refer to the clause 6.2.

4.5.3 Revoking Security Options

In the ISP mode, you can revoke all of these options like the serial configuration mode. When you forget the password, enter this mode to change or delete it.

5 Methods for I/O control

5.1 MODBUS/TCP

CIE-H12 supports Modbus/TCP. By using this protocol, it remotely monitors and controls I/O devices. To use this method, your application should support this protocol.

5.1.1 Related Parameters

Parameters	Descriptions
Modbus/TCP	Using Modbus/TCP for controlling I/O ports of CIE-H12.
Slave	The slave responses by queries from the Master
Master	The Master sends queries to the slaves
Poll Interval	the period for sending queries (Unit: ms, Minimum value: 10)
Unit ID	ID for identifying the device or the pair of devices.
Input Port Base Address	Initial address of the input ports
Output Port Base Address	Initial address of the output ports
Passive Connection	waiting for accepting a Modbus/TCP connection
Active Connection	requesting a Modbus/TCP connection
Multiple Connection	The numbers for multiple Modbus/TCP connections.
Control Method of (FC XX)	Control method for the output ports of the slave (Single / Multiple)
Control Method of (AND/OR)	Control method for the output ports of the master (AND / OR)
Peer Address	Peer's IP address when CIE-H12 performs active connections
Peer Port	Peer's local port when CIE-H12 performs active connections
Local Port	CIE-H12's local port when CIE-H12 performs passive mode.
Input Change Notification	A function for immediate notification with changing the IP address.
Initialize the output port state	The Output port will be changed to the [Initial State] when Modbus/TCP is disconnected. (Upper version 1.5A)
Macro	Applying macro function on the output port
Initial State	Output port value when CIE-H12 boots up.

Table 5-1 Related Parameters

We do not recommend changing the [Input Port Base Address] and [Output Port Base Address] unless you need to.

5.1.2 Modbus/TCP Slave Mode

According to the standard Modbus/TCP, users can use a Modbus/TCP manager to control and monitor their I/O devices. You can set CIE-H12 to the [Slave] item to [Slave] mode. The [Passive] connection is recommended in this mode and the [Peer Port] should be 502.

Modbus/TCP Mode	Slave
TCP Connection	Passive
TCP Port	502

Table 5-2 values for standard Modbus/TCP

Configure the proper values of [Unit ID], [Input Port Base Address], and [Output Port Base Address].

5.1.3 Modbus/TCP Master Mode

In this mode, CIE-H12 operates as a Modbus/TCP master. As a master CIE-H12 transmits its input information to the slave and outputs the slave's input value to its output port after reading the value periodically. At this time, CIE-H12 controls the output ports with not only bit unit (individually) but also word unit (at once)

- FC 16(Multiple ports)
CIE-H12 controls the output ports and monitors the input ports of slaves with WORD unit by FC16 (write multiple registers) and FC 03 (read holding registers)
- FC 05(Single port)
CIE-H12 controls the output ports and monitors the input ports of slaves with BIT unit by FC05 (write single coil) and FC02 (read discrete inputs).

5.1.4 TCP Connection Modes

In the standard of Modbus TCP, the master program makes a connection to the slave using port number 502. However, sometimes Modbus/TCP devices try connecting to the master actively. For this case, CIE-H12 supports the active connection mode.

The passive connection	<ul style="list-style-type: none"> - Standard Modbus/TCP. - Remote host connects to CIE-H12. - Port number that is used for communication must be designated. - Depending on the setting of multiple connections, up to 8 hosts can be connected.
The active connection	<ul style="list-style-type: none"> - CIE-H12 tries to establish a connection to the remote host. - The IP address (or host name) and port number of the remote host is required.

Table 5-3 the passive / active connection

5.1.5 Initial Output Value

The initial value of CIE-H12's output port can be configured. The output ports are set to ON or OFF according to the value of [Initial State] at the boot time.

5.1.6 Write Pulse

By using the function code 105, you can give the signal of pulse type to the output ports. This means the output signal is kept during the specific time configured by users.

5.1.7 Communication with HMI

In case of communication HMI with the CIE-H12, please refer to the address table below.

☞ **CIE-H12's default Input address is 0 and default Output address is 8.**

Port	Bit/Word	R/W	Function Code	Default Modbus Address	Default HMI Address	
Di	Word	Read	03	0	40001	
			04		30001	
Di0	Bit	Read	02	0	10001	
			03	0	40001.0	
			04		30001.0	
Di1		Bit	Read	02	1	10002
				03	0	40001.1
				04		30001.1

Table 5-4 Digital input port address

Port	Bit/Word	R/W	Function Code	Default Modbus Address	Default HMI Address
Do	Word	Read	03	8	40009
		Write	06		
			16		
Do0	Bit	Read	01	8	00009
		Write	05		
			15		
			105		
		Read	03	8	40009.0
		Write	06		
16					

Table 5-5 Digital output port address

☞ **Refer to the document [Modbus/TCP of ezTCP] on our website for details.**

5.2 Macro Mode

This mode lets users set the values of the output ports with simple macros. Since CIE-H12 reflects the values according to the macro expressions which are configured by users in advance, it is useful to make a specific device operate automatically using signals from various sensors. Check [Macro] options on ezManager to activate this mode.

☞ ***While using the Macro mode, users can not control the output ports through HTTP or Modbus/TCP.***

5.2.1 Operator

The algorithm used in the Macro mode is Boolean algebra. In this case, the AND, OR, NOT are used as operators. Parenthesis may also be used.

The operators are executed in order of precedence: parenthesis > NOT > AND > OR.

Each operator is represented by the following symbols.

Name	Sign	Description
Parenthesis	()	Since calculations within the parenthesis have the highest priority, they will be calculated first. Nested parentheses are allowed.
NOT	/	An operand that follows a NOT operator is toggled. (If an operand is 0, it will be changed to 1. If it is 1, it will be changed to 0.)
AND	*	If both operand values surrounding an AND operator are 1, the result value will be 1. But if otherwise, the result will be 0.
OR	+	If both operand values surrounding an OR operator are 0, the result value will be 0. But if otherwise, the result will be 1.

Table 5-6 the operators

5.2.2 Operand

Operands used in macro mode are each input port. Each input port is designated with i0 and i1 symbol based on their sequence. Since capital letters are not recognized, they can also be written as I0 and I1.

☞ ***The output ports could not be used as an operand.***

5.2.3 An Example of Equations

Here are two examples. In the expressions, spaces between the two operands will be ignored.

Input Port	Equations	Description
Do0-(A)	$i0 + i1$	Perform bit OR i0 and i1
Do0-(B)	$/(i0 * i1)$	Perform bit AND i0 and i1. Then, toggle the result

Table 5-7 an example of equation

The following is the output values coming out as a result of expressions of input values.

Input ports		Output port	
i0	i1	Do0-(A)	Do0-(B)
0	0	0	1
0	1	1	1
1	0	1	1
1	1	1	0

Table 5-8 the logic table of the table 5-5

5.3 Monitoring and controlling on Web (HTTP)

After starting the web browser, type CIE-H12's IP address after typing http:// in the address bar to connect to CIE-H12.

If a password for CIE-H12 is set, the following window will be popped up.

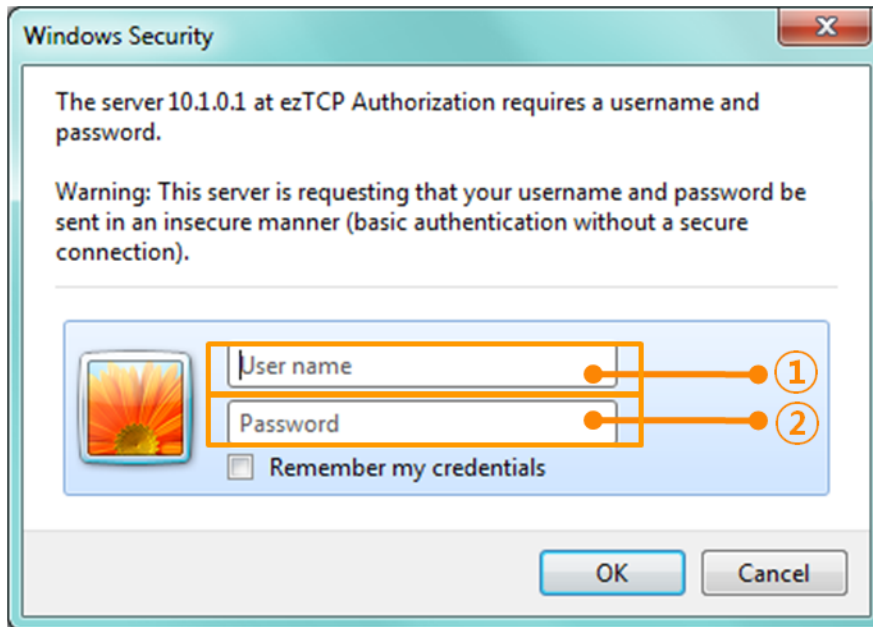

Figure 5-1 authentication with a password

- ① [User name] is not required. Leave blank or put a random name.
- ② [Password] should be the same with a password which is set through the ezManager.

5.3.1 Changing port number for HTTP

In case you cannot use the port number 80(default port number for HTTP) because the ISP (Internet Service Provider) blocks the port, you can change that port number.

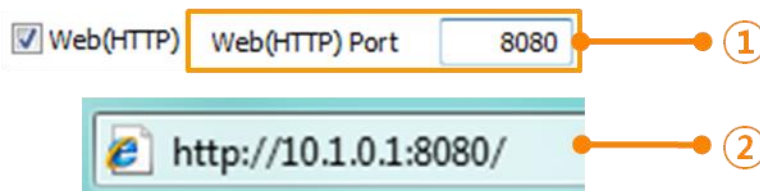

Figure 5-2 changing port number for HTTP

- ① Input a port number to the [Web(HTTP) Port] text box.
- ② Input the IP address of CIE-H12 along with the changed port number and "http://"

5.3.2 Uploading Users' Webpage

This function is available to anyone who can make HTML files. If you get some simple syntax, it is possible to monitor and control the I/O ports with your webpage made by yourself.

- Upgrading HTML files
CIE-H12 has a default webpage when it is manufactured in the factory. For advanced users, we have been offering some examples (sample web pages) based on various technologies such as CSS and J query.

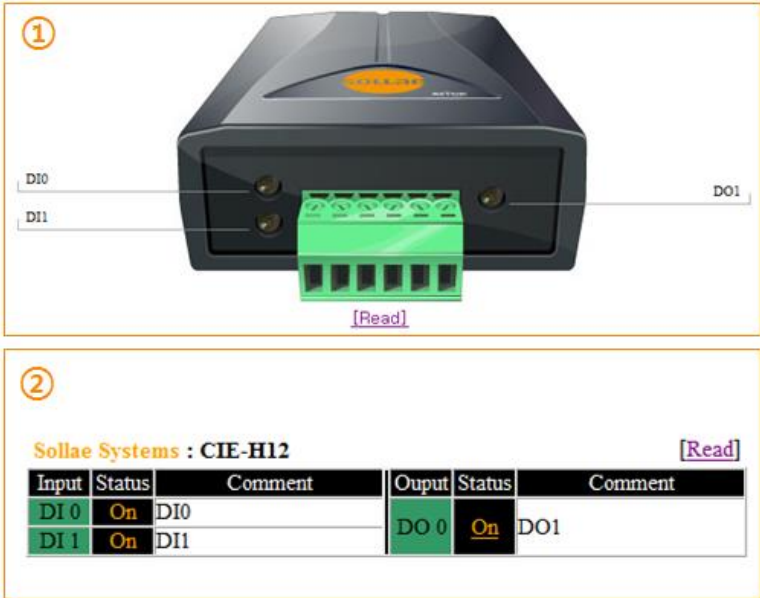

Figure 5-3 examples of webpage

- ① Default image based / advanced CSS / JQuery
- ② Text based

6 System Management

6.1 Upgrading Firmware

6.1.1 Firmware

Firmware is a type of software for operation of CIE-H12. If it is needed to add function or fix bugs, the firmware will be modified and released. We recommend that users keep using the latest released firmware.

6.1.2 Processes

- Downloading the latest released firmware
Download the newest firmware file. We update our homepage when a new firmware is released. You can find it on our website.
- Entering ISP mode
Enter ISP mode to download firmware file to CIE-H12.
- Run a TFTP client and ready to send the F/W file
Run a TFTP client program. ezManager is equipped with the client program. Click the [Change F/W / HTML] button.

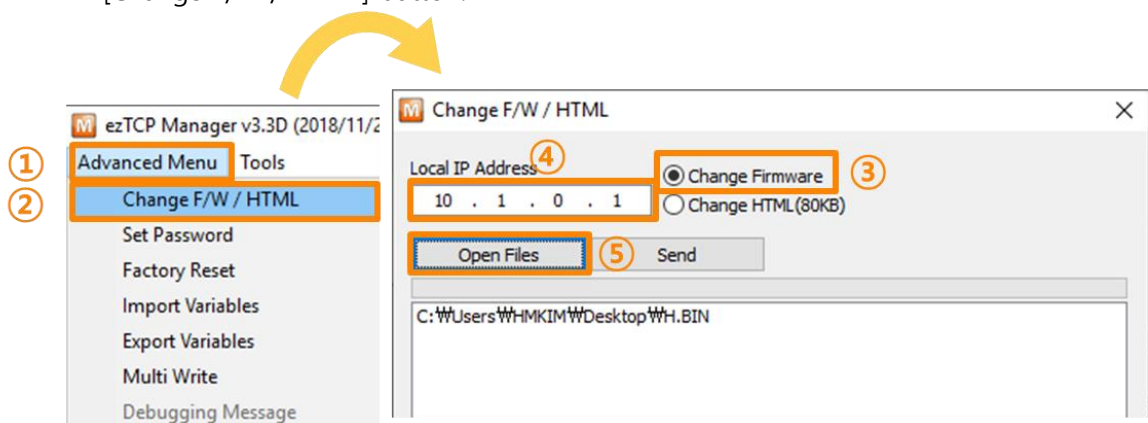

Figure 6-1 running TFTP client

- ① Click the [Advanced Menu]
- ② Click the [Change F/W / HTML] button to run TFTP client
- ③ Select the [Change Firmware] radio button
- ④ Input the IP address of CIE-H12 to the [Local IP Address] text box
- ⑤ Press the [Open Files] button and choose the firmware file

- Checking firmware file and Sending

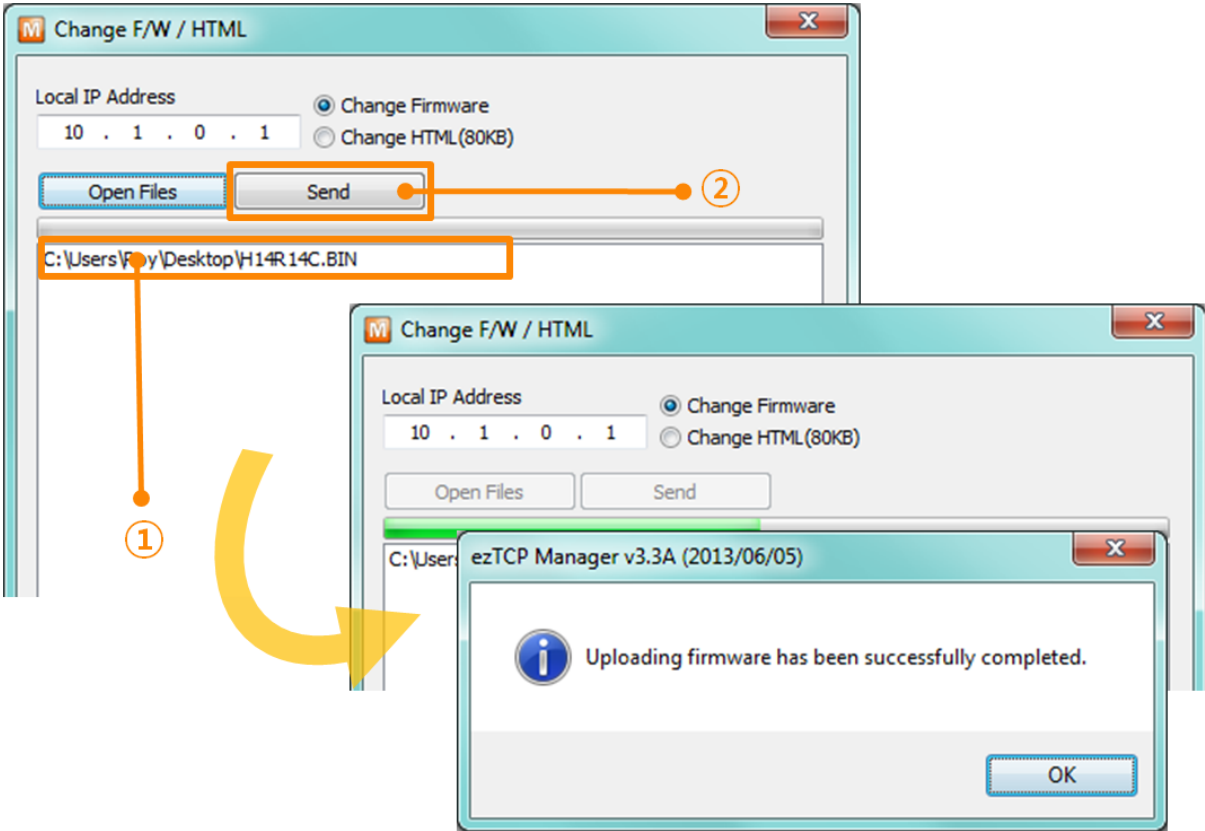

Figure 6-2 sending firmware file

- ① Check if the name and path of the firmware file are correct
- ② Click the [Send] button
- ③ Confirm the completed message

6.2 Changing Homepage

6.2.1 Webpage

CIE-H12 comes preloaded with a webpage to facilitate control and monitoring through HTTP.

6.2.2 Processes

- Making Users' homepage or Downloading sample files
Make your own homepage file or use sample homepage files freely available to download at our web site.
- Entering ISP mode
Enter ISP mode to send HTML files to CIE-H12.
- Writing Web(HTTP) port number and selecting size of Web(HTTP)

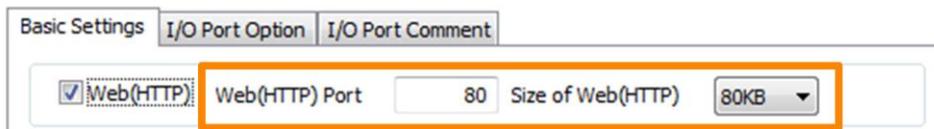

Figure 6-3 Web Basic Settings

☞ ***80KB or 96KB for the Size of Web(HTTP) is allowed.***

- Running a TFTP client and ready to send the HTML files
Run a TFTP client program. ezManager is equipped with the client program. Click the [Change F/W / HTML] button.

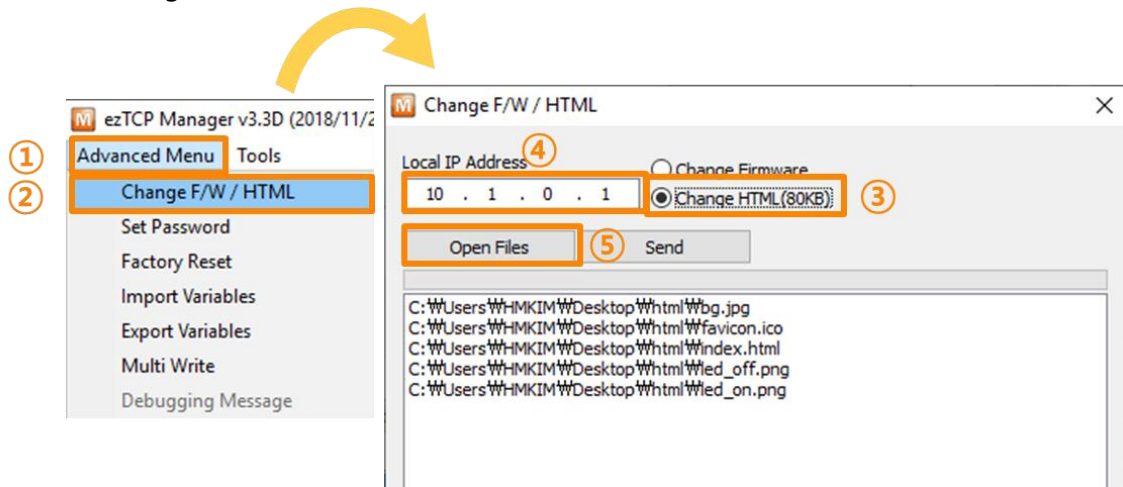

Figure 6-4 running TFTP client

- ① Click the [Advanced Menu]
- ② Click the [Change F/W / HTML] button to run TFTP client
- ③ Select the [Change HTML] radio button
- ④ Input the IP address of CIE-H12 to the [Local IP Address] text box
- ⑤ Press the [Open Files] button and choose the HTML file

- Checking files and Sending

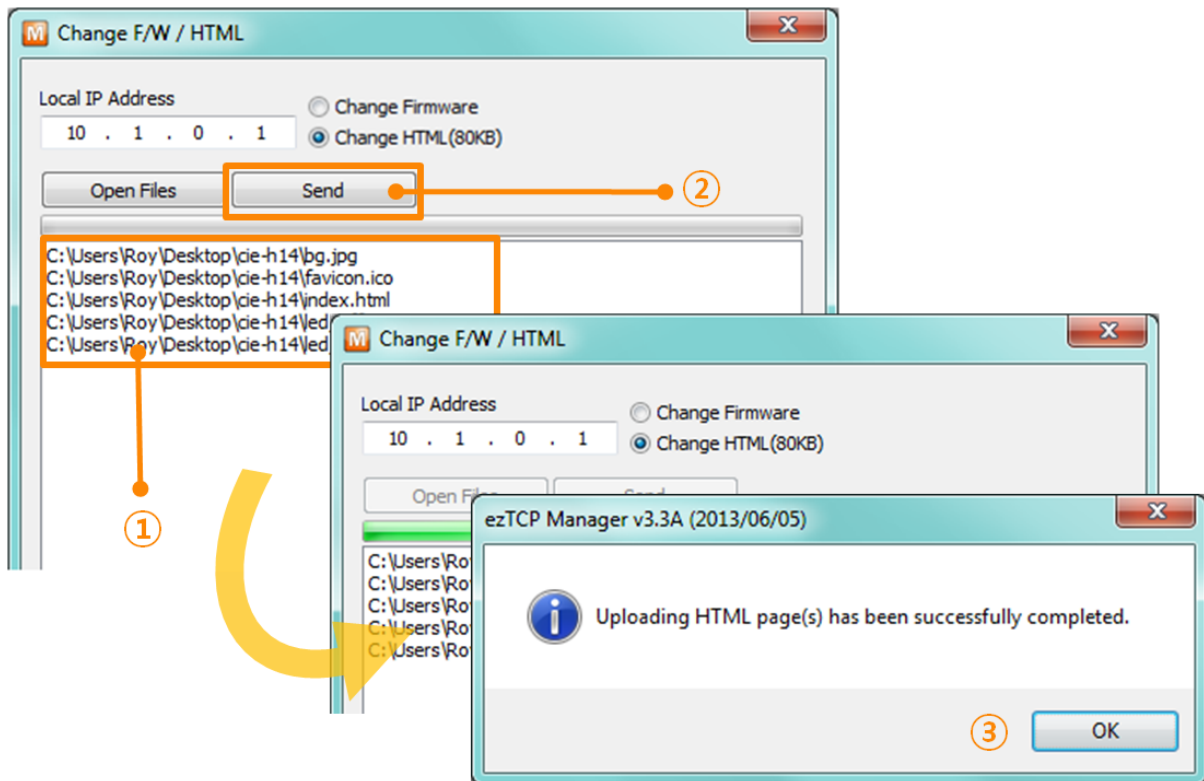

Figure 6-5 sending firmware file

- ① Check if the name and path of the html file including all images are correct
- ② Click the [Send] button
- ③ Confirm the completed message

6.3 Status Monitoring

6.3.1 Using TELNET

Once the [TELNET] option is activated, users can remotely log in to CIE-H12. If a password is set, users should input the password.

After that, messages from CIE-H12 appear as shown in the figure below.

☞ Starting with firmware version 2.0A, you can login by entering "sollae" without setting a password.

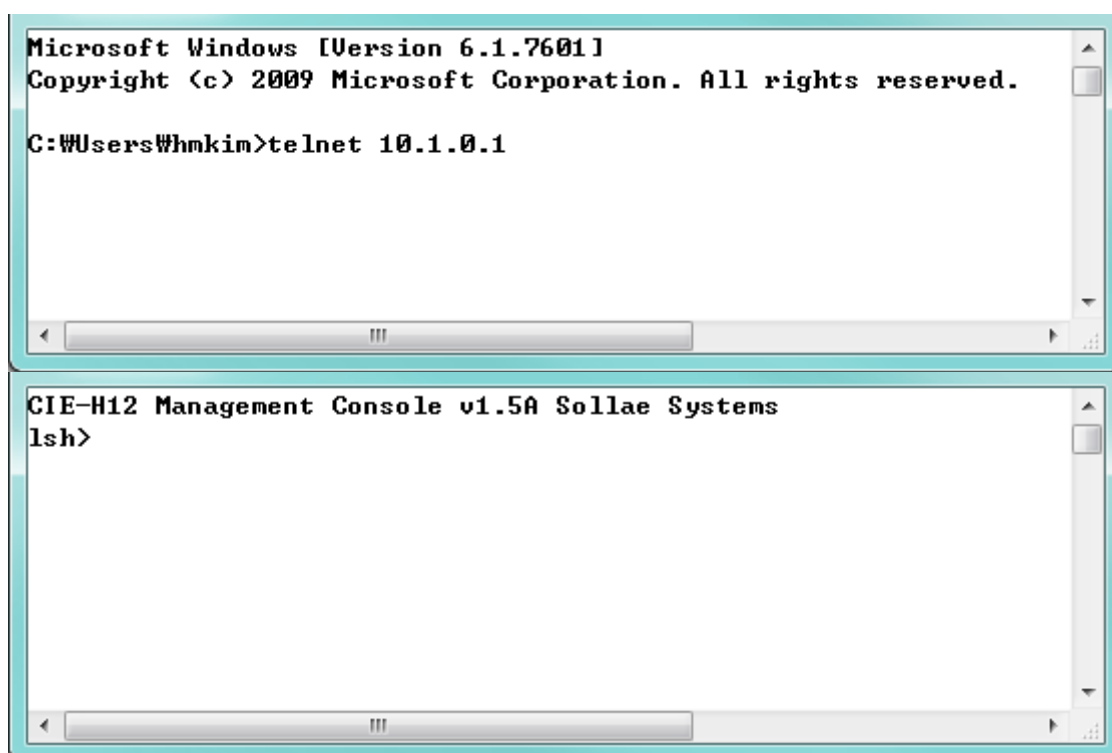

Figure 6-6 log in to CIE-H12 on TELNET

You can check multiple states with the following commands.

command	option	description	usage
st	net	Network Status	lsh>st net
	uptime	System Uptime	lsh>st uptime
sc	[OP1][OP2]	Session Control	lsh>sc com1 close

Table 6-1 Commands for checking states

- st net

“st net” command displays the current network states of all sessions.

```
lsh>st net
```

proto	name	local address	peer address	sendq	state
TCP	tty	10.11.0.12< 23>	10.11.0.67<51768>	140	ESTABLISHED
TCP	http7	0.0.0.0< 80>	0.0.0.0< 0>	0	LISTEN
TCP	http6	0.0.0.0< 80>	0.0.0.0< 0>	0	LISTEN
TCP	http5	0.0.0.0< 80>	0.0.0.0< 0>	0	LISTEN
TCP	http4	0.0.0.0< 80>	0.0.0.0< 0>	0	LISTEN
TCP	http3	0.0.0.0< 80>	0.0.0.0< 0>	0	LISTEN
TCP	http2	0.0.0.0< 80>	0.0.0.0< 0>	0	LISTEN
TCP	http1	0.0.0.0< 80>	0.0.0.0< 0>	0	LISTEN
TCP	http0	0.0.0.0< 80>	0.0.0.0< 0>	0	LISTEN
TCP	mbus0	0.0.0.0< 502>	0.0.0.0< 0>	0	LISTEN

Figure 6-7 “st net” command

- st uptime

“st uptime” command shows amount of time since CIE-H12 has booted up.

```
lsh>st uptime
00:00:10.68 up 0 days
```

Figure 6-8 “st uptime” command

- sc

“sc” command is used when users close a session. [OP1] means the name of session, and [OP2] should be “CLOSE”.

```
lsh>sc tty close
tty: closed
```

Figure 6-9 “sc” command

☞ *Lower-case letters are only allowed to use “sc” command.*

6.3.2 Checking status by ezManager

Status of CIE-H12 can be monitored by [Status] button on ezManager. By using the [Refresh Every 1 Second] option in the status window, the status is automatically updated in every second.

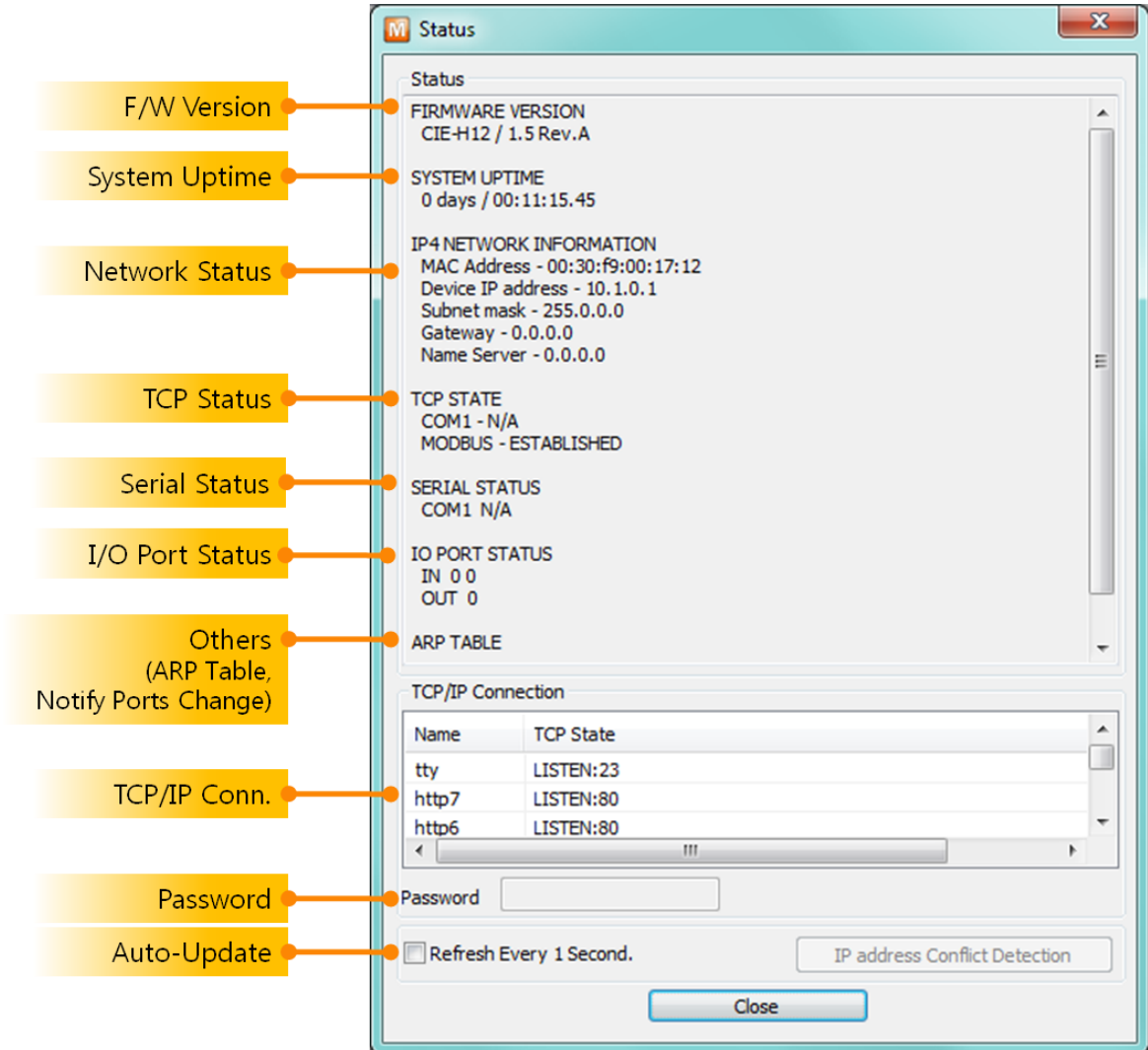

Figure 6-10 status window of ezManager

- **FIRMWARE VERSION**
The name of model and the version of firmware are displayed here.
- **SYSTEM UPTIME**
Operating time of CIE-H12 is displayed since it boots up.
- **IP4 NETWORK INFORMATION**
All information about related items with IP Address including the MAC address is shown here. It works even if the IP address is assigned from DHCP.

- TCP STATE

TCP status of each port is shown in this section.

message	description
LISTEN	waiting for requests of a TCP connection
CLOSE	a TCP connection is closed
SYN_SENT	send "SYN" segment to make a TCP connection
ESTABLISHED	When a TCP connection is established
N/A	Not Available

Table 6-2 TCP STATE

- I/O PORT STATUS

This represents I/O ports' status. '1' means HIGH(ON) and '0' means LOW(OFF).

- ARP TABLE

This part shows ARP table on CIE-H12. When a TCP connection is established or UDP data communication is performed, the information of IP and MAC address is automatically stored in the ARP table. This information is held for 1 minute. If there is no data communication for 1 minute, the information will be removed.

- Notify Ports Change (IOTRAP STATE)

This part shows E-mail address what you entered, when you use the function [Notify Input or Output Port Change].

- TCP/IP Connection

In this section, the same information with TCP STATE is displayed with IP address and port number. A difference is that users can terminate a TCP connection. When right click on a session, a small pop-up window is created.

- Password

This text box is activated when CIE-H12 has a password. If users want to close the TCP connection, this password has to be correctly filled.

- Refresh Every 1 Second.

If this option is checked, ezManager sends query in every second.

7 Additional Functions

7.1 Security

7.1.1 Restriction of Access (ezTCP Firewall)

On the [Option] tab of ezManager, users can set restriction of access function with filtering MAC and IP address.

- Allowed MAC Address

If this option has a value of MAC address, the device which has the MAC address is only permitted to access.

- Allowed IP Address

This is to define hosts with IP address or range of IP address allowed to access. The range is defined by multiplying [IP address] and [Network Mask] in bit unit.

- Examples

IP address	network mask	allowed IP address range
10.1.0.1	255.0.0.0	10.1.0.1 ~ 10.255.255.254
10.1.0.1	255.255.255.0	10.1.0.1 ~ 10.1.0.254
192.168.1.4	255.255.255.255	192.168.1.4

Table 7-1 examples of defining allowed IP range

- Apply to ezManager

[Apply to ezManager] is for applying above two restrictions to ezManager functions like [Search], [Read], [Write], etc.

7.1.2 Setting Password

A password can be used to protect CIE-H12 from TELNET login or changing environmental parameters by hosts who are not designated. The maximum length is 8 bytes of Alphabet or number.

☞ ***When you want to revoke all of these restrictions, change the mode of CIE-H12 to the ISP mode. All restrictions are removable and communication with ezManager is revoked in the ISP mode.***

7.2 Option Tab Functions

7.2.1 Notify IP Change

CIE-H12 can be a TCP server even though it is assigned the IP address automatically. Using [Notify IP Change] function, it sends its IP address with the host name to the specific server. There are 3 types of functions provided: DDNS, TCP and UDP.

- Dynamic Domain Name Service (DDNS)

CIE-H12 supports DDNS function offered by DynDNS to manage its changed IP address as a host name. Therefore, you have to make an account and create host names on the website of DynDNS before use this.

☞ *All about service usage of an account could be changed according to the policy of DynDNS.*

☞ *Homepage of DynDNS: <http://dyn.com/dns/>*

Figure 7-1 setting DDNS

- ① Select the [DDNS (dyndns.org)] item.
- ② 40,320 is a fixed value.
- ③ Input the ID of DDNS account.
- ④ Input the password of the account.
- ⑤ Input one of the host names which you created on your account.

- TCP/UDP

In case you have an own server and want to manage the information about changed IP addresses, you are allowed to use TCP/UDP for using this option. The [Data Type] can be selected as ASCII or hexadecimal, and the [Interval] is available on configuration.

☞ *Refer to the document [Notify IP Change] on our website for details.*

7.2.2 Debugging Message

By using [Debugging] option, users can receive debugging messages from CIE-H12 on the network.

- ☞ ***When you are facing a problem about the TCP connection or data communication, use this function and send us the stored file. We can use it for finding out the reason of your problem.***
- ☞ ***Debugging messages are broadcasted to entire network via UDP so it might cause serious network traffic. Remember you should turn the option off after using it.***

- Setting debugging option

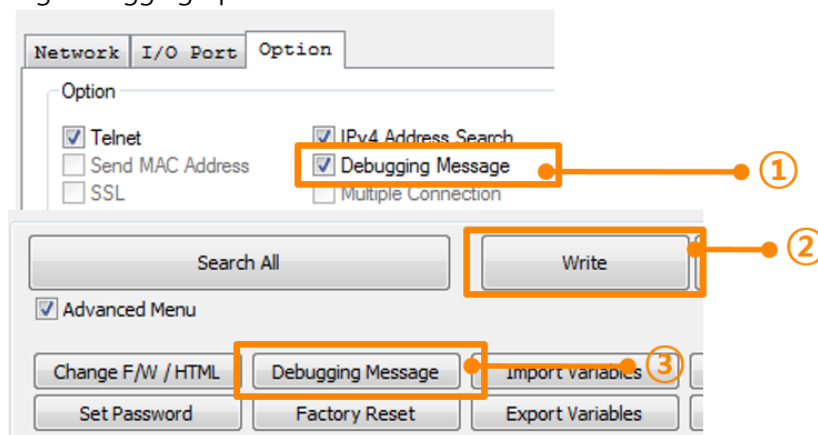

Figure 7-2 setting debugging option

- ① Check the [Debugging Message] option
- ② Press the [Write] button
- ③ After checking the [Advanced Menu], click the [Debugging Message] button. And then, the debugging message window appears on your screen as shown below.

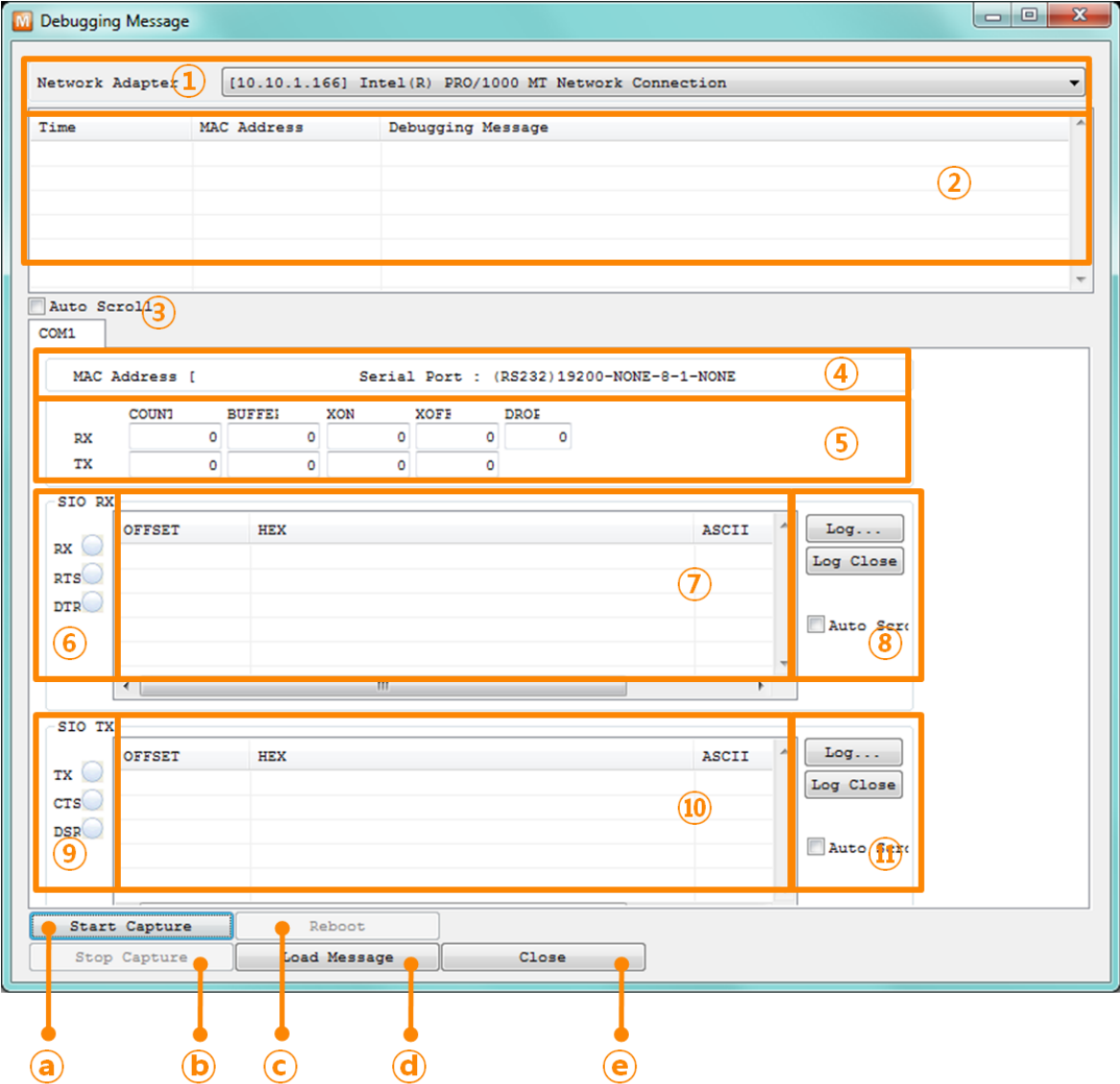

Figure 7-3 debugging message window

- ① Pull down menu for selecting a network adapter
- ② Place for showing received debugging messages from CIE-H12 over the network
- ③ Auto update to display the latest captured file on the screen of ②
- ④ MAC Address Information of a selected message
- ⑤ ~ ⑪ Unavailable
- a) To start capturing debugging messages from CIE-H12
- b) To stop capturing debugging messages from CIE-H12
- c) Unavailable
- d) [Load Message] is for loading a debugging log file to display
- e) Closing debugging message window

7.3 I/O Tab Functions

7.3.1 Notify Input or Output Port Change

When input or output port is changed, you can receive an email for notification from CIE-H12 using SMTP protocol. When ports you selected are changed, status of CIE-H12 is sent to the Email address you entered.

- Setting E-mail notification option

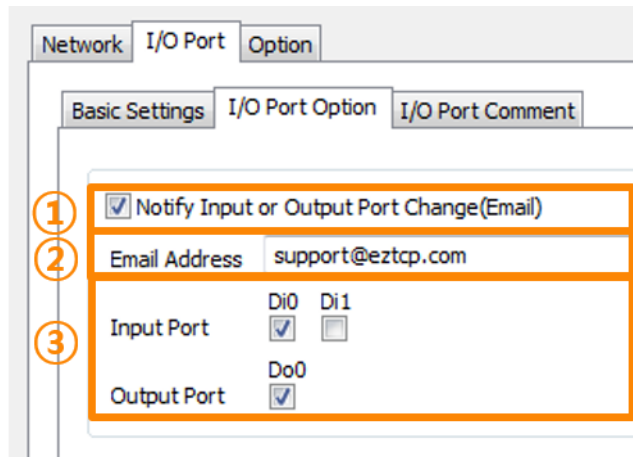

Figure 7-4 Notify Input or Output Port Change

- ① Check Notify Input or Output port change (Email)
- ② Enter your Email address
- ③ Select input and output ports

When an event is triggered, CIE-H12 keeps trying to send E-mails until it succeeds although they are not sent for a reason.

```

I/O port status notification
CIE-H12 [no-reply@eztcp.com]
보낸 날짜: 2013-08-14 (수) 오전 10:45
받는 사람: support@eztcp.com

[Input]
DI0: OFF > OFF
DI1: OFF > OFF

[Output]
DO0: OFF > ON

Product Information
CIE-H12 / 1.5A

System Uptime
0 days / 00:00:19.28

Network Information
MAC Address - 00:30:f9:00:17:12
IPv4 Address - 112.1.1.1
Subnet Mask - 255.255.255.128
Gateway - 112.171.14.1
Name Server - 112.1.1.1

TCP State
COM1 - N/A
modbus0 - ESTABLISHED
http0 - LISTEN
http1 - LISTEN
http2 - LISTEN
http3 - LISTEN
http4 - LISTEN
http5 - LISTEN
http6 - LISTEN
http7 - LISTEN

Comment

```

Figure 7-5 I/O port status notification email

7.3.2 Valid Time

CIE-H12 only recognizes signals of the input ports as the valid signals when the signal lasts for the [Valid Time]. If the signals are not maintained for the [Valid Time], the input signals will be ignored. The unit used for the [Valid Time] is 1ms. However, because the accuracy is only guaranteed in 10ms, the designated values are rounded down in units of 10ms.

7.3.3 Delay

Output values are reflected to CIE-H12's output ports later than the time set to [Delay]. For example, if [Delay] is set to '0', the output values are reflected to the output ports immediately. Although it is allowed to set the values in 1ms, it is accurate to 10ms, rounded down.)

☞ ***If the timer for the [Delay] is already running, all the subsequent orders for giving signals to the output ports are ignored.***

7.4 Internet Switch

As one of the control methods, all of our digital I/O controllers support Modbus/TCP.

According to the standard of this protocol, a system is composed of master and slave. Our controllers support both master and slave modes, so you can make various systems such as 1:1 or 1:N by combining some of the products.

You can make a system that transfers input information through the TCP/IP network and outputs the value. This function is called as "Internet Switch".

☞ ***Refer to the [Internet Switch], [Combinations of digital I/O Controllers] documents on our web site for details.***

8 Self-Test in Trouble

When users are in trouble with using CIE-H12, make sure of the following steps first.

8.1 Searching problem with ezManager

- Confirming types of configuration utility
CIE-H12 can be configured by ezManager.
- Cancelling the Firewall operation
In case of being blocked by firewalls of a personal computer or network block, you must cancel all the firewalls before searching CIE-H12.

☞ ***Most of vaccine programs have firewall functions so it can cause some trouble to search CIE-H12. Close or pause these programs before searching the product.***

- Stable supply of the power
Check if the power is supplied continually. If the power is constantly supplied, the LED on RJ45(Orange) of CIE-H12 blinks slowly.
- Connection with the network
Make sure that the network connection is fine including Ethernet cable. In this step, we recommend that users connect CIE-H12 with PC directly or in the same network hub.
- Checking options of restriction
In case that restriction of access is activated, the communication with ezManager will be unavailable. When users are in this situation, make CIE-H12 operate in ISP mode.

8.2 Connection Problem over Modbus/TCP

- Checking parameters related with TCP/IP

When CIE-H12 has a private network IP address, personal computer's IP address has to be on the same sub network. Check if the IP address and local port number are correct. In case of a fixed IP address, the subnet mask, gateway IP address and DNS IP address should be configured.

Table 8-1 major parameters related with Modbus/TCP

Slave or Master
Local IP Address, the connection mode (Active / Passive), Peer Address and Peer Port, Subnet Mask, Gateway IP Address, DNS IP Address, DDNS option and etc.

- PING Test

Confirm the connection over the network by PING test. If CIE-H12 does not send any reply from the request, check the network environment.

- Firewall

In case the networks which need strong security, the access may be denied by their firewall. Under this circumstance, users should ask the person in charge of their network to release ports which will be used. (Ex: TCP 502, UDP 50005)

- Operation Mode

A TCP connection is not possible when CIE-H12 is operating in the ISP or Serial Configuration mode.

- Connection Mode

To make a TCP connection, both a server (passive mode) and a client (active mode) should exist. If there are only servers or clients, the TCP connection cannot be established.

- ezTCP Firewall

When users set the ezTCP firewall with MAC and IP address, any hosts cannot be reachable to it except for the hosts who have the allowed MAC and IP address. Inactivate the option or check the setting is correct.

- Checking the TCP status

TCP is a protocol connected one to one without multiple connections function except for using the Multiple-connection. Because of this, if a device is on a TCP connection, other requests are denied. If users are in this situation, check the network status by connecting on TELNET or using ezManager.

8.3 Communication Problem over Modbus/TCP

- Checking Modbus/TCP parameters
Check all the related parameters that [Unit ID], [Input Port Base Address], [Output Port Base Address], [Poll Interval] and [Notify Input change].
- Checking which mode is using
In case of MACRO or serialized Modbus/TCP, you can control the outputs of CIE-H12. Turn the mode off if those modes are using.

☞ *Contact us if you have any questions about above steps or our products.*

9 Related material

9.1 Technical Documents

You can find the following technical documents at our website.

- Datasheet
- Modbus/TCP of ezTCP
- Combinations of I/O Controllers
- Digital Pulse Output
- IP Change Notification (DDNS)
- Modmap Users' manual
- etc

9.2 Smart phone application

- ezManager (iOS)
- ezManager (Android)
- TCP Console (iOS)

10 Technical Support and Warranty

10.1 Technical Support

If you have any question regarding operation of the product, visit Customer Support FAQ corner and the message board on Sollae Systems' web site or send us an email at the following address:

- E-mail: support@eztcp.com
- Website Address for Customer Support: <http://www.eztcp.com/en/support/>

10.2 Warranty

10.2.1 Refund

Upon the customer's request to refund the product within two weeks after purchase, Sollae Systems will refund the product.

10.2.2 Free Repair Services

For product failures occurring within 2 years after purchase, Sollae Systems provides free repair services or exchange the product. However, if the product failure is due to user's fault, repair service fees will be charged or the product will be replaced at user's expense.

10.2.3 Charged Repair Services

For product failures occurring after the warranty period (2 years) or resulting from user's fault, repair service fees will be charged and the product will be replaced at user's expense.

11 Precaution and Exemption from Liability

11.1 Precaution

- Sollae Systems is not responsible for product failures occurring due to user's alteration of the product.
- Specifications of the product are subject to change without prior notice for performance improvement.
- Sollae Systems does not guarantee successful operation of the product if the product was used under conditions deviating from the product specifications.
- Reverse engineering of firmware and applications provided by Sollae Systems is prohibited.
- Use of firmware and applications provided by Sollae Systems for purposes other than those for which they were designed is prohibited.
- Do not use the product in an extremely cold or hot place or in a place where vibration is severe.
- Do not use the product in an environment in which humidity is high or a lot of oil exists.
- Do not use the product where there is caustic or combustible gas.
- Sollae Systems does not guarantee normal operation of the product under the conditions a lot of noise exists.
- Do not use the product for a purpose that requires exceptional quality and reliability relating to user's injuries or accidents – aerospace, aviation, health care, nuclear power, transportation, and safety purposes.
- Sollae Systems is not responsible for any accident or damage occurring while using the product.

11.2 Exemption from Liability

11.2.1 English version

In no event shall Sollae Systems Co., Ltd. and its distributors be liable for any damages whatsoever (including, without limitation, damages for loss of profit, operating cost for commercial interruption, loss of information, or any other financial loss) from the use or inability to use the CIE-H12 even if Sollae Systems Co., Ltd. or its distributors have been informed of such damages.

The CIE-H12 is not designed and not authorized for use in military applications, in nuclear applications, in airport applications or for use in applications involving explosives, or in medical applications, or for use in security alarm, or for use in a fire alarm, or in applications involving elevators, or in embedded applications in vehicles such as but not limited to cars, planes, trucks, boats, aircraft, helicopters, etc..

In the same way, the CIE-H12 is not designed, or intended, or authorized to test, develop, or be built into applications where failure could create a dangerous situation that may result in financial losses, damage to property, personal injury, or the death of people or animals. If you use the CIE-H12 voluntarily or involuntarily for such unauthorized applications, you agree to subtract Sollae Systems Co., Ltd. and its distributors from all liability for any claim for compensation.

Sollae Systems Co., Ltd. and its distributors entire liability and your exclusive remedy shall be Sollae Systems Co., Ltd. and its distributors option for the return of the price paid for, or repair, or replacement of the CIE-H12.

Sollae Systems Co., Ltd. and its distributors disclaim all other warranties, either expressed or implied, including, but not limited to, the implied warranties of merchantability and fitness for a particular purpose, with respect to the CIE-H12 including accompanying written material, hardware and firmware.

11.2.2 French version

- Documentation

La documentation du boîtier CIE-H12 est conçue avec la plus grande attention. Tous les efforts ont été mis en œuvre pour éviter les anomalies. Toutefois, nous ne pouvons garantir que cette documentation soit à 100% exempt de toute erreur. Les informations présentes dans cette documentation sont données à titre indicatif. Les caractéristiques techniques peuvent changer à tout moment sans aucun préavis dans le but d'améliorer la qualité et les

possibilités des produits.

- Copyright et appellations commerciales

Toutes les marques, les procédés, les références et les appellations commerciales des produits cités dans la documentation appartiennent à leur propriétaire et Fabricant respectif.

- Conditions d'utilisations et limite de responsabilité

En aucun cas Sollae Systems Co., Ltd. ou un de ses distributeurs ne pourra être tenu responsable de dommages quels qu'ils soient (intégrant, mais sans limitation, les dommages pour perte de bénéfice commercial, interruption d'exploitation commerciale, perte d'informations et de données à caractère commercial ou de toute autre perte financière) provenant de l'utilisation ou de l'incapacité à pouvoir utiliser le boîtier CIE-H12, même si Sollae Systems Co., Ltd. ou un de ses distributeurs a été informé de la possibilité de tels dommages.

Le boîtier CIE-H12 est exclusivement prévu pour un usage en intérieur, dans un environnement sec, tempéré (+10 °C à +40°C) et non poussiéreux. Le boîtier CIE-H12 n'est pas prévu, ni autorisé pour être utilisé en extérieur, ni de façon embarquée dans des engins mobiles de quelque nature que ce soit (voiture, camion, train, avion, etc...), ni en milieu explosif, ni dans des enceintes nucléaires, ni dans des ascenseurs, ni dans des aéroports, ni dans des enceintes hospitaliers, ni pour des applications à caractère médical, ni dans des dispositifs de détection et d'alerte anti-intrusion, ni dans des dispositifs de détection et d'alerte anti-incendie, ni dans des dispositifs d'alarme GTC, ni pour des applications militaires.

De même, le boîtier CIE-H12 n'est pas conçu, ni destiné, ni autorisé pour expérimenter, développer ou être intégré au sein d'applications dans lesquelles une défaillance de celui-ci pourrait créer une situation dangereuse pouvant entraîner des pertes financières, des dégâts matériel, des blessures corporelles ou la mort de personnes ou d'animaux. Si vous utilisez le boîtier CIE-H12 volontairement ou involontairement pour de telles applications non autorisées, vous vous engagez à soustraire Sollae Systems Co., Ltd. et ses distributeurs de toute responsabilité et de toute demande de dédommagement.

En cas de litige, l'entière responsabilité de Sollae Systems Co., Ltd. et de ses distributeurs vis-à-vis de votre recours durant la période de garantie se limitera exclusivement selon le choix de Sollae Systems Co., Ltd. et de ses distributeurs au remboursement de votre produit ou de sa réparation ou de son échange. Sollae Systems Co., Ltd. et ses distributeurs

démentent toutes autres garanties, exprimées ou implicites.

Tous les boîtiers CIE-H12 sont testés avant expédition. Toute utilisation en dehors des spécifications et limites indiquées dans cette documentation ainsi que les court-circuit, les chocs, les utilisations non autorisées, pourront affecter la fiabilité, créer des dysfonctionnements et/ou la destruction du boîtier CIE-H12 sans que la responsabilité de Sollae Systems Co., Ltd. et de ses distributeurs ne puissent être mise en cause, ni que le boîtier CIE-H12 puisse être échangé au titre de la garantie.

- Rappel sur l'évacuation des équipements électroniques usagés

Le symbole de la poubelle barré présent sur le boîtier CIE-H12 indique que vous ne pouvez pas vous débarrasser de ce dernier de la même façon que vos déchets courants. Au contraire, vous êtes responsable de l'évacuation du boîtier CIE-H12 lorsqu'il arrive en fin de vie (ou qu'il est hors d'usage) et à cet effet, vous êtes tenu de le remettre à un point de collecte agréé pour le recyclage des équipements électriques et électroniques usagés. Le tri, l'évacuation et le recyclage séparés de vos équipements usagés permettent de préserver les ressources naturelles et de s'assurer que ces équipements sont recyclés dans le respect de la santé humaine et de l'environnement. Pour plus d'informations sur les lieux de collecte des équipements électroniques usagés, contacter votre mairie ou votre service local de traitement des déchets.

12 History

Data	Version	Comments	Author
2011.08.01	1.0	○ Initial release	Roy LEE
2011.08.02	1.1	○ Product's picture has been replaced.	Roy LEE
2011.08.04	1.2	○ Gap of the output port has been corrected.	Roy LEE
2011.12.22	1.3	○ Descriptions of DynDNS service has been changed.	Amy Kim
2012.04.25	1.4	○ Descriptions regarding recommendation for a high capacity relay has been added	Amy Kim
2012.06.26	1.5	○ Change description of network interface ○ Remove description about PPPoE and DHCP ○ Extend the warranty period to two years	Amy Kim
2013.02.07	1.6	○ Change voltage conditions of output port	Amy Kim
2013.05.16	1.7	○ Add related material ○ Add Exemption From Liability ○ Add Features	Amy Kim
2013.08.21	1.8	○ Add function of Pulse Control through WEB ○ Modify the screen capture images to new version. ○ Add function of Notify Input or Output Port Change	Amy Kim
2013.12.26	1.9	○ Correct some errors and expressions	Amy Kim
2014.11.06	2.0	○ Remove description about Sending MAC Address	Sara Lee
2015.02.16	2.1	○ Add comments of Notify Input or Output Port Change	Amy Kim
2016.03.24	2.2	○ Add explanation for telnet login.	Jack Kim
2019.04.10	2.3	○ Add Communication with HMI	Sara Lee
2019.08.02	2.4	○ Modify the voltage specification of the input port. ○ Modify screenshots of ezManager ○ Add 7.4 Internet Switch	Amy Kim